

SOUND DEVICES



SL-6

Powering and Wireless System for the 688

User Guide

Legal Notices

Product specifications and features are subject to change without prior notification.

Copyright © 2017 Sound Devices, LLC. All rights reserved.

This product is subject to the terms and conditions of a software license agreement provided with the product, and may be used in accordance with the license agreement.

This document is protected under copyright law. An authorized licensee of this product may reproduce this publication for the licensee's own personal use. This document may not be reproduced or distributed, in whole or in part, for commercial purposes, such as selling copies or providing educational services or support.

This document is supplied as a technical guide. Special care has been taken in preparing the information for publication; however, since product specifications are subject to change, this document might contain omissions and technical or typographical inaccuracies. Sound Devices, LLC does not accept responsibility for any losses due to the user of this guide.

Trademarks

The "wave" logo and USBPre are registered trademarks; FileSafe, PowerSafe, SuperSlot, MixAssist, QuickBoot, and Wave Agent are trademarks of Sound Devices, LLC. Mac and OS X are trademarks of Apple Inc., registered in the U.S. and other countries. Windows and Microsoft Excel are registered trademarks of Microsoft Corporation in the U.S. and other countries. All other trademarks herein are the property of their respective owners.

FCC Notice

This device complies with part 15 of the FCC Rules. Operation is subject to the following two conditions: (1) This device may not cause harmful interference, and (2) This device must accept any interference received, including interference that may cause undesired operation.

FCC Part 15.19(a)(3)

Manual Conventions

Symbol	Description
>	This symbol is used to show the order in which you select menu commands and sub-options, such as: Main Menu > Audio indicates you press the Menu button for the Main Menu, then scroll to and select Audio by pushing the Control Knob.
+	A plus sign is used to show button or keystroke combinations. For instance, Ctrl+V means to hold the Control key down and press the V key simultaneously. This also applies to other controls, such as switches and encoders. For instance, MIC+HP turn means to slide and hold the MIC/TONE switch left while turning the Headphone (HP) encoder. METERS+SELECT means to hold the METERS button down as you press the SELECT encoder.
ⓘ	A note provides information and important related recommendations. The text for notes also appears italicized in a different color.
⚠	A cautionary warning about a specific action that could cause harm to you, the device, or cause you to lose data. Follow the guidelines in this document or on the unit itself when handling electrical equipment. The text for cautionary notes also appears in a different color, bold and italicized.

SL-6 User Guide • Rev 4-A • February 15, 2017

This document is distributed by Sound Devices, LLC in online electronic (PDF) format only. E-published in the USA.

www.sounddevices.com

support@sounddevices.com

Sound Devices, LLC
E7556 Road 23 and 33
Reedsburg, Wisconsin USA

Direct: +1 (608) 524-0625
Toll Free: (800) 505-0625
Fax: +1 (608) 524-0655

Revision History

This table provides the revision history of this guide.

Rev#	Date	Firmware Version	Description
1-A	June 2015	2.00	Initial Official Publication
1-B, 1-C	Aug 2015	2.00	Added & revised section on "Automatic Receiver Output Setup" on page 16.
3-A	April 2016	3.00	Added information on new RF scanning and frequency assignment feature.
3-B	June 2016	3.10	Added new information on turning off power to individual Rx slots. Also added interactive links to new Demo Videos for some features, such as RF scanning and IR Sync.
4-A	Feb 2017	4.50	Added "Receiver Details Screen - Example C" section detailing new support for the Sennheiser EK-6042 two-channel wireless receiver.

Table of Contents

SL-6 Powering and Wireless System

Front Panel.....	7	Radio Frequency (RF) Filter	12
Right Panel.....	8	Using Wireless Receivers	13
Left Panel.....	8	Selecting a Wireless Source	14
Powering with the SL-6	9	Accessing the Receiver Overview Screen.....	14
Power Screen.....	10	Unislots Receivers.....	15
SL-6 DC Outputs	10	Using SuperSlot Receivers	15
SL-6 Power Settings	10	Automatic Receiver Output Setup.....	16
Turning Off Power to Rx Slots.....	11	Receiver Details Screen - Example A	17
Using Antenna Distribution.....	11	Receiver Details Screen - Example B.....	19
Antenna Bias Power.....	12	Receiver Details Screen - Example C.....	21

SL-6 Specifications

Powering	25
Antenna Distribution	26
Physical.....	26

SL-6 Powering and Wireless System

The SL-6 offers built-in NP-1 battery powering for the 688 mixer, slot receivers, plus four additional DC outputs for external peripherals, as well as built-in antenna distribution.

Using Sound Devices' SuperSlot™ interconnection standard, the SL-6 offers all powering, monitoring, audio interconnection and control needed for SuperSlot-compatible receivers. Its RF scan feature provides quick coordination and configuration of SuperSlot Rx.

① *The SL-6 attaches to the top panel of the 688. Instructions for attaching the SL-6 to your mixer is provided in the [SL-6 Quick Start Guide](#), shipped with the accessory and as a PDF download from the [Sound Devices website](#).*

Topics in this section include:

- ▶ Front Panel
- ▶ Right Panel
- ▶ Left Panel
- ▶ Powering with the SL-6
- ▶ Turning Off Power to Rx Slots
- ▶ Using Antenna Distribution
 - ▶ Antenna Bias Power
 - ▶ Radio Frequency (RF) Filter
- ▶ Using Wireless Receivers
- ▶ Unislot Receivers
- ▶ Using SuperSlot Receivers
 - ▶ Automatic Receiver Output Setup
 - ▶ Receiver Details Screen - Example A
 - ▶ Receiver Details Screen - Example B
 - ▶ Receiver Details Screen - Example C
- ▶ Scanning for Radio Frequencies

Front Panel

The front panel of the SL-6 has the following features:

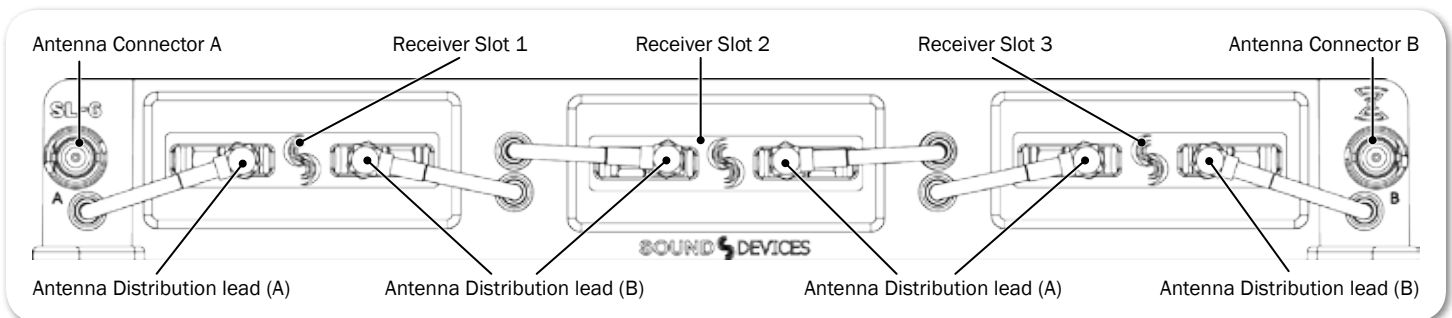

FEATURE	DESCRIPTION
Receiver Slots	Each slot accepts one (single- or dual-channel) SuperSlot or unislot receiver. The connection provides power to the receiver and connects the receiver's audio output directly to the 688.
Antenna Distribution leads	SMA connectors with right-angle adapters are used to connect receivers to the SL-6 antenna distribution system.
Antenna Connectors	BNC connectors are used for attaching external antennas to the SL-6 antenna distribution system. ① <i>Use BNC to SMA adapters, included with the SL-6, for antennas with SMA connectors.</i>

Right Panel

The right panel of the SL-6 has the following features:

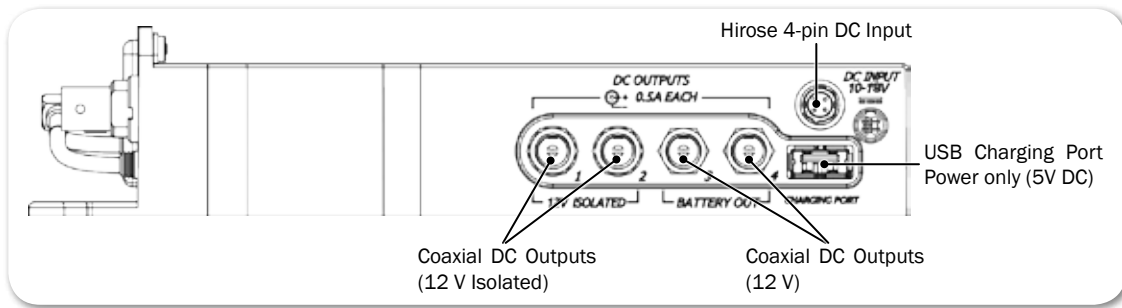

FEATURE	DESCRIPTION
Hirose 4-pin DC Input	Hirose 4-pin DC input for powering the SL-6 and 688. Power must be attached to this connector or an NP-1 battery must be inserted to power the SL-6 and 688.
Coaxial DC Outputs (12 V Isolated)	Isolated 12 V DC outputs that draw from the active SL-6 power source (Hirose 4-pin or NP-1). Each output is on by default but can be switched off from the POWER section of the Main menu.
Coaxial DC Outputs (12 V)	12 V DC outputs that draw from the active SL-6 power source (Hirose 4-pin or NP-1). Each output is on by default but can be switched off from the POWER section of the Main menu.
USB Charging Port	Standard USB 5 V DC output that draws from the active SL-6 power source (Hirose 4-pin or NP-1). ❗ <i>The USB port on the SL-6 is designed for charging only, not for data transfer.</i>

Left Panel

The left panel of the SL-6 provides the NP-1 battery compartment, which accepts NP-1 batteries (14 V, Li-ion or NiMH).

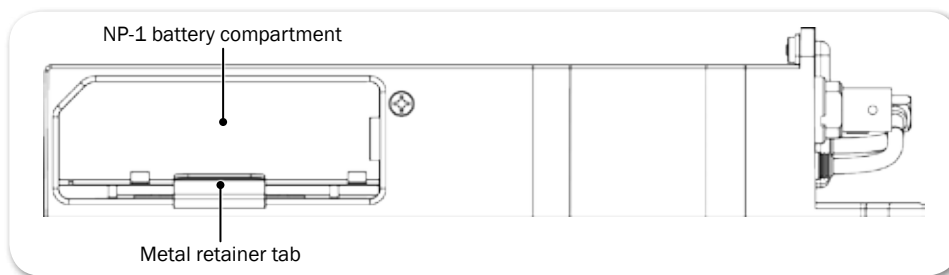

To insert an NP-1 battery:

1. Pull the retainer tab out until it clicks. It will stop when protruding about 1 inch from the unit.
2. Place the end of the NP-1 battery with the metal contacts into the battery compartment with contacts facing down.
3. Push the NP-1 battery into the battery compartment until the retainer tab securely snaps over the end of the battery.

Powering with the SL-6

The SL-6 features two power inputs: NP-1 battery and external DC. The SL-6, its attached receivers, the 688 (and CL-6, if connected), and any devices powered from the SL-6 DC outputs require one of these power sources to operate. When both SL-6 power sources are depleted or disconnected, the SL-6 Power-Safe™ battery will keep the SL-6 and attached devices powered for 10 seconds while recording is stopped. If any power source is attached to the 688's external DC input, or if internal AA batteries are present, the 688 (and CL-6, if attached) will continue to operate using those power sources.

- ① *Power sources connected directly to the 688 (external DC or the internal AA batteries) will not power the SL-6 or any attached peripheral devices.*

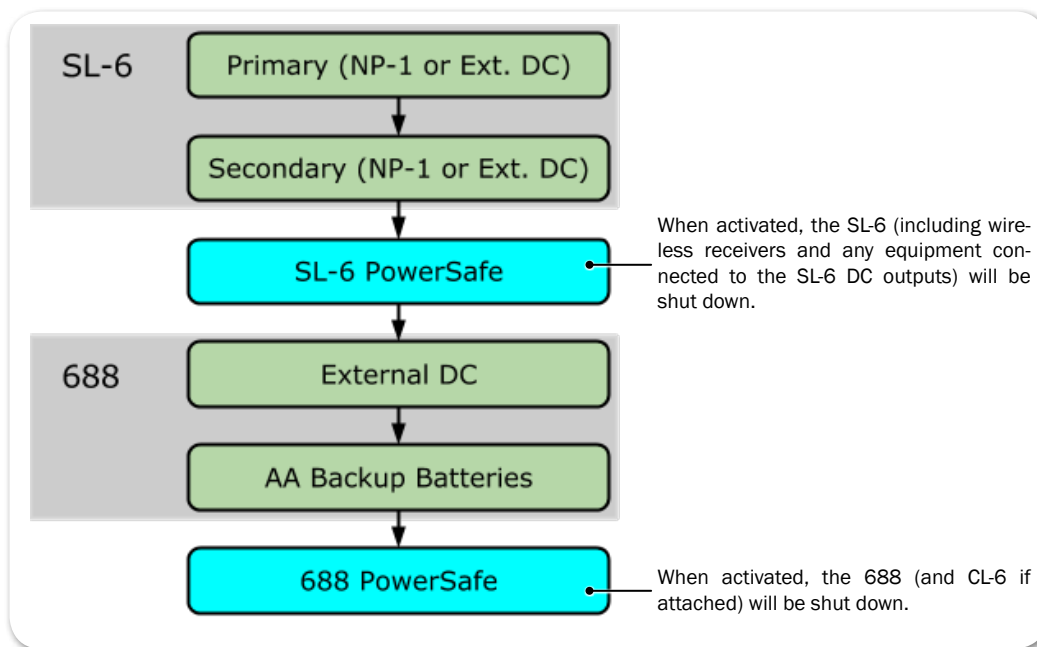

When the SL-6 is attached, the DC voltage indicator (battery icon) on the 688's Main screen will display NP or SL to indicate which power source is active.



External DC Power via SL-6
Normal Voltage
(Green)



Battery Power via NP-1 in SL-6
Warning Voltage
(Yellow)

- ① *The color, which could also appear red (critical) or orange (low voltage), indicates a source's power level.*

Power Screen

When the SL-6 is attached to the 688, the mixer’s Power screen displays the voltage level of the attached NP-1 battery, the SL-6 external DC power source, and the SL-6 PowerSafe battery, in addition to the 688’s own power sources.

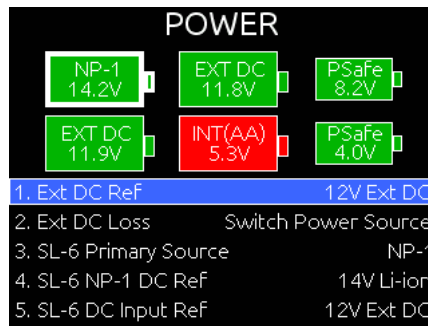

SL-6 DC Outputs

The SL-6 right panel features four DC power outputs via locking coaxial connectors (numbered 1 through 4) and a USB charging port. Outputs 1 through 4 are 12 V DC outputs that draw from the active SL-6 power source. Outputs 1 and 2 are isolated and do not share a common ground with the system.

To turn a DC output on or off:

1. Press the MENU button to access the Main menu.
2. Turn and press the Headphone encoder to select POWER > SL-6 Power Outputs.
3. Turn and press the Headphone encoder to select an output and set it to On or Off.

To protect NP-1 batteries from exceeding their maximum discharge current, when total power draw reaches 45 watts, the 688 displays a warning message. When total power draw reaches 50 watts (SWIT battery) or 53 watts (IDX battery), the DC outputs will be turned off in descending order (output 4 - 1) until power draw drops below 45 watts. First the USB charging port will be disabled, then DC Output 4, DC Output 3, DC Output 2, and finally DC Output 1. You can manually turn outputs back on when power draw drops below 45 watts.

SL-6 Power Settings

When the SL-6 is attached, the following settings are available in the Main menu’s POWER section.

SUB-MENU NAME	DESCRIPTION	OPTIONS
SL-6 Primary Source	Selects primary power source.	<ul style="list-style-type: none"> • NP-1 • DC Input

SUB-MENU NAME	DESCRIPTION	OPTIONS
SL-6 NP-1 DC Ref	Calibrates the power level indicator according to the type of NP-1 battery in use. The default is 14V Li-ion.	<ul style="list-style-type: none"> • 14V Li-ion • NiMH
SL-6 DC Input Ref	Calibrates the power level indicator according to the type of external DC source. The default is 12V Ext DC.	<ul style="list-style-type: none"> • 12V Ext DC • NiMH • Expanded NiMH • 12V Lead Acid • 14V Li-ion • Full Range
SL-6 Power Outputs	Sub-menu where each DC power output can be turned on or off.	<ul style="list-style-type: none"> • Output 1 (12V Isolated) • Output 2 (12V Isolated) • Output 3 (Battery) • Output 4 (Battery) • USB Charging Port

Turning Off Power to Rx Slots

When the SL-6 is attached, the 688 provides a sub-menu option that lets users power off unused receiver slots in the SL-6.

- ① *Sound Devices recommends that you do not manually power on/off receivers, or change output type/level, from the Rx interface when connected to the SL-6 as this may affect optimal performance of the 688/SL-6.*

To power on or off Rx slots 1-3 in an SL-6:

1. Press MENU.
2. Select SL-6 > Receiver Slot Power. The Receiver Slot Power screen appears.

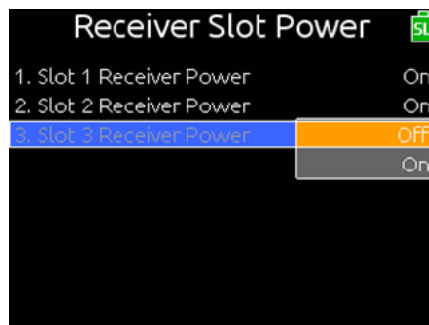

3. Select Slot 1, 2 or 3. Options include On or Off. By default, all slots are powered on.

- ① *The Receiver Slot Power settings are not stored as part of factory defaults or custom configurations saved in Quick Setup files.*

Using Antenna Distribution

Two BNC antenna connections (A and B) are provided for attaching antennas to the antenna distribution system. Antennas with an SMA connection may be used with a BNC to SMA adapter, which is included with the SL-6.

The antennas on the SL-6 provide improved diversity performance due to wider spacing than those directly mounted on the receivers. This can reduce the instances of signal dropouts due to destructive cancellation of reflecting RF signals.

Good performance will be obtained when antennas are mounted directly to the SL-6 BNC connectors. Quarter wave whip antennas are typically used in this scenario with the SL-6 housing providing the reference plane.

Better performance will usually be observed with a higher elevation of the receive antenna. This can provide a more direct line of sight to the transmitter which improves signal strength. Shoulder mounted antennas are one example. Care should be used with antenna selection in this scenario. Some antennas, such as quarter wave (also known as quarter wave whip antennas), require a ground plane (metallic reflective surface usually perpendicular to the antenna). Others, such as a half wave antenna and log periodic antenna (Also referred to as paddle antenna), can be remotely mounted and do not require a ground plane.

For best performance, Sound Devices recommends directional remote antennas. Independent 12 volt antenna bias for powering active antennas is provided at each SL-6 antenna BNC connector.

Many variables are involved with a successful RF link. As such, results for each operation may vary.

Antenna Bias Power

If needed, 12V bias power may be provided to each antenna.

To supply bias power to an antenna:

1. Press the MENU button to access the Main menu.
2. Do one of the following:
 - ▶ Turn and press the Headphone encoder to select SL-6 > Antenna A Power.
 - ▶ Turn and press the Headphone encoder to select SL-6 > Antenna B Power.
3. Turn and press the Headphone encoder to turn bias power on or off.

Radio Frequency (RF) Filter

The SL-6 provides RF filtering which can allow operation in the presence of interfering signals such as cell phones and TV stations. Selection is provided for four different frequency ranges of operation.

To enable the RF filter:

1. Press the MENU button to access the Main menu.

2. Turn and press the Headphone encoder to select SL-6 > Antenna Filter.
3. Turn and press the Headphone encoder to select a filter range.
Options include: Wideband, 470-700 MHz, 470-590 MHz, and 580-700 MHz.
Wideband represents the guaranteed range of operation of an SL-6. Signals above and below these frequencies may be usable. Filter selection depends on the presence and magnitude of interfering signals. Generally, the narrowest filter setting will give the best performance.

Using Wireless Receivers

The SL-6 supports SuperSlot and unislot receivers on a DB-25 connection. The SL-6 receiver slots provide power and audio connection to both types of receivers. Additionally, SuperSlot receivers can be controlled from the 688 interface.

To connect antennas to the SL-6:

- ▶ Connect each antenna directly to each BNC Antenna Connector on the SL-6.

To connect a receiver to the SL-6:

- ① *Mounting procedures for receiver models may vary. Refer to the receiver manufacturer's documentation for your receiver and follow the specific mounting instructions.*
 - ⚠ ***Neither the Lectrosonics SRb5P nor SRc5P can be fitted into slot 1 of the SL-6. Using the blue spacer (provided with the receivers), both can be connected to slot 2 or 3.***
1. Power off the 688.
 2. The SL-6 ships with rubber slot protectors that hold the SMA antenna connectors with right-angle adapters secure during transport. These must be removed prior to use, so remove the connector, then pull the rubber cover off to expose the chosen slot.
 - ① *Do not discard protectors; Sound Devices recommends storing the connectors with their right-angle adapters in the rubber slot protectors when not in use.*
 3. Slide the receiver into slot on the SL-6. If necessary, use the provided spacer.
 4. Screw the four mounting screws through the receiver and into the SL-6.
 - ⚠ ***Use only the screws provided with the receiver. Longer screws can damage the SL-6.***
 5. Attach each antenna distribution lead to the receiver by screwing the SMA connector on both sides of the receiver.

Selecting a Wireless Source

SL-6 wireless receiver outputs are routed to 688 inputs via the SL-6 Routing screen. One wireless receiver output can be routed to one 688 input.

To route a receiver to an input:

1. Slide the PFL switch to access the Input Settings screen for the respective input.
2. Press the Headphone encoder to display the list of available input sources.
3. Turn and press the Headphone encoder to select SL-6. The SL-6 Routing screen is displayed. Wireless receiver outputs are represented as rows and 688 inputs are represented as columns. Blue boxes indicate active assignments.

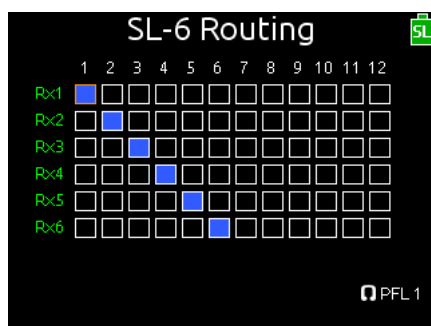

4. Do any of the following:
 - ▶ Turn the Select encoder to move the orange highlight vertically and press the encoder to activate or deactivate the route.
 - ▶ Turn the Headphone encoder to move the orange highlight horizontally and press the encoder to activate or deactivate the route.

① *When a wireless receiver output is routed to a 688 input, that channel's input source is set to SL-6. When a wireless receiver output is not routed from a 688 input, that channel's input source is set to OFF.*

Accessing the Receiver Overview Screen

The Receiver Overview screen displays summary information for all receivers connected to the SL-6. Information on this screen is read-only.

To access the Receiver Overview screen via button shortcut:

- ▶ HP + METERS: Press the Headphone encoder, then press the METERS button.

To access the Receiver Overview screen from the Main menu:

1. Press the MENU button.
2. Turn and press the Headphone encoder to select SL-6 > Receiver Overview.

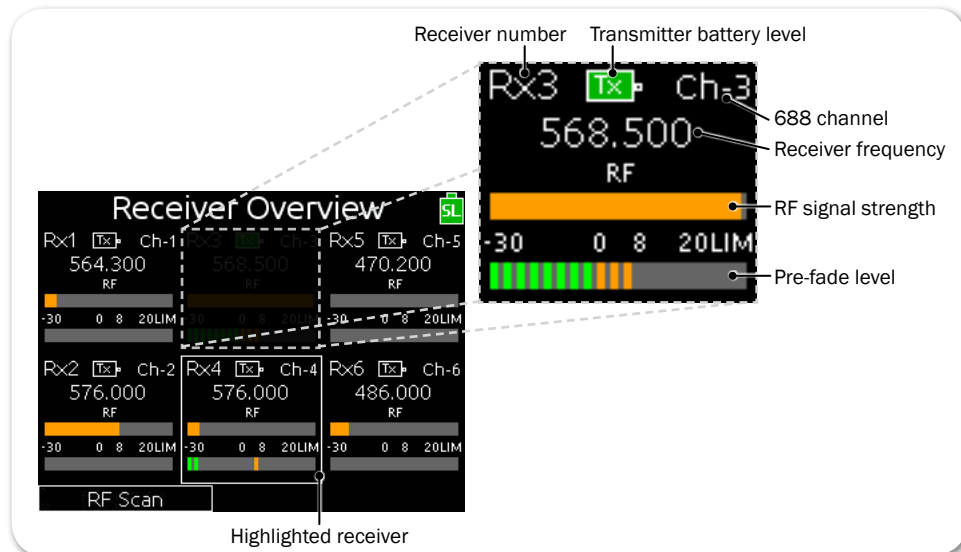

When supported by the transmitter, the transmitter battery level is indicated by the color of the battery icon: Green = over 50%, Yellow = over 20%, Orange = over 10%, Red = less than 10%. Whenever the transmitter battery level information is not supported by the transmitter, the icon is black.

Unislot Receivers

Configuration of unislot receivers is done on the receivers themselves, not from the 688; therefore, the Receiver Details screen is not available for unislot receivers.

Using SuperSlot Receivers

When the 688 is powered on, the SL-6 will power receivers automatically; attached SuperSlot receivers will boot up with their panel buttons locked, because SuperSlot receivers are configured from the 688 user interface.

- ① *Sound Devices recommends, if the 688 is powered on, you do not power down attached SuperSlot receivers. If SuperSlot receivers are powered down manually (by unlocking the receivers' front panel buttons), the receivers will not be recognized until they are powered on manually and the 688 is rebooted.*

Detailed information for each attached SuperSlot receiver is displayed on the 688 via a Receiver Details screen. Adjustments to SuperSlot receivers may be made from this screen, including RF scanning and frequency assignment. See [Scanning for Radio Frequencies](#) for more information.

The screen's title will show the type or model of the receiver. Based on your receiver, information on screen could vary; refer to the receiver manufacturer's documentation provided with your receiver(s) for more information.

To access Receiver Details screens from the Receiver Overview screen:

1. METERS + HP: Press the METERS button, then push in the Headphone en-

coder to access the Receiver Overview screen.

2. Turn and press the Headphone encoder to select a receiver.

To directly access a specific Receiver Details screen:

- ▶ **HP + PFL (1-6):** Press and hold the Headphone encoder, and then slide the PFL switch that corresponds to the receiver number and channel you want to view—left for even channels and right for odd channels.

For instance, to view the Receiver Details screen for channel 1 on the first slotted receiver, slide PFL 1 to the left. Slide the same switch right for channel 2 on the first slotted receiver.

① *This HP + PFL (1-6) shortcut bypasses the Receiver Overview screen that shows data for all slotted receivers.*

Receiver tuning is presented uniquely, based on each manufacturer’s receiver model. Current tuning values are displayed in outlined boxes on the Receiver Details screen.

To adjust a receiver’s tuning:

1. Access the Receiver Details screen.
2. Turn and press the Headphone encoder to enter editing mode for the selected field. The background color of the field will become blue to indicate editing mode.
3. Turn the Headphone encoder to adjust the value.
4. Press the Headphone encoder to accept the value.

For more information regarding Receiver Details screens, see [Receiver Details Screen - Example A](#), [Receiver Details Screen - Example B](#), and [Receiver Details Screen - Example C](#).

Automatic Receiver Output Setup

When using SuperSlot receivers with the SL-6, some receiver settings are automatically set by the mixer for optimized performance.

These settings include:

RECEIVER	SETTING	DESCRIPTION
Lectrosonics SRb & Lectrosonics SRc	SETUP > LEVEL = -6	To achieve optimal audio level and to match the SRb or SRc output to the mixer’s input stage for best dynamic range, the 688 automatically sets the SRb or SRc’s gain level to -6, and the phase to +. There is no reason to manually set the SRb or SRc to any other level. Use the 688’s trim control to make any necessary adjustments.
	SETUP > PHASE = +	
Wisycom MCR-42S	The following settings are applied only when all receivers in the SL-6 are AES-3 compatible:	

RECEIVER	SETTING	DESCRIPTION
	MENU > Advanced > LINE Mode = AES-3	
	MENU > Advanced > Edit RX1/RX2 > Audio Out > AES3 max lev = 0 dBFS	
	MENU > Advanced > Edit RX1/RX2 > Sig. phase = 0°	
	The following settings are applied whenever some of the receivers in the SL-6 are not AES-3 compatible:	
	MENU > Advanced > LINE Mode = Analog	
	MENU > Advanced > Edit RX1/RX2 > Audio Out > LINE max lev = 0 dBU	
	MENU > Advanced > Edit RX1/RX2 > Sig. phase = 0°	

Receiver Details Screen - Example A

Information provided on the Receiver Details screen depends on your receiver model. This guide provides a couple of examples.

The following example of the Receiver Details screen is for a Lectrosonics SRC. Refer to Lectrosonics documentation for further explanation of these settings.

① *This section applies to Lectrosonics SuperSlot-based receivers or those upgraded to SuperSlot. Earlier versions without the SuperSlot upgrade are treated as unislot receivers; therefore, the Receiver Details screen is not be accessible.*

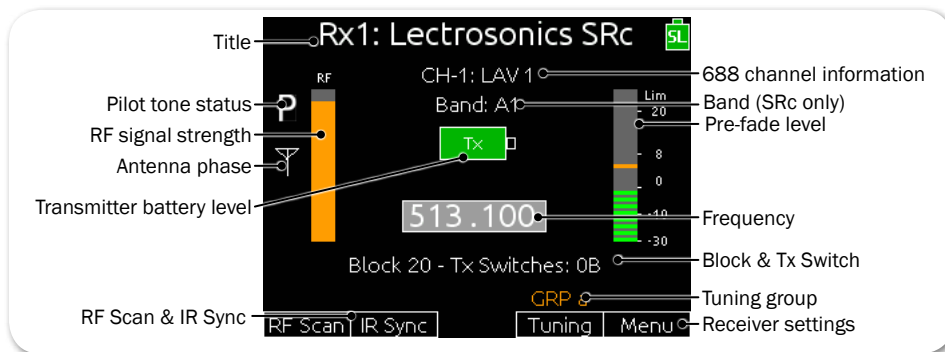

SCREEN ELEMENT	DESCRIPTION
Title	Screen's title displays the number of the receiver followed by the manufacturer and model name.
Pilot tone status	Different letters are displayed based on status of pilot tone. <ul style="list-style-type: none"> • Solid P: Pilot tone from transmitter is present. • Flashing P: Pilot tone is not present. • Solid, lower-case b: Pilot tone is bypassed.
RF signal strength	Displays the strength of the RF signal.
Antenna phase	The antenna icon is displayed when Diversity mode is set to Switch. Icon will flip vertically when antenna phase is inverted.
Transmitter battery level	Displays the level of the transmitter's battery. The transmitter battery level is indicated by the color of the battery icon and the level of the bar. Green = over 50%, Yellow = over 20%, Orange = over 10%, Red = less than 10%. When the transmitter battery level information is not supported, the icon is black. <p>① <i>This information is only provided when supported and supplied by the transmitter.</i></p>

SCREEN ELEMENT	DESCRIPTION
RF Scan	<p>Runs a scan of the Lectrosonics receiver's RF block or band, and then displays the frequency graph, allowing users to assign a frequency to the receiver's channels.</p> <p>To assign a frequency:</p> <ul style="list-style-type: none"> ▶ Use the Headphone encoder to scroll the graph; press it in to select and assign a frequency.
IR Sync	<p>Puts the receiver into IR Sync mode directly from the 688, enabling synchronization of the transmitter frequency to the Rx frequency.</p> <p>To initiate IR sync:</p> <ul style="list-style-type: none"> ▶ Slide the MIC/TONE switch to the right and confirm by selecting OK when prompted. A status dialog appears while syncing is in progress. <div data-bbox="846 646 1273 968" style="text-align: center;"> </div> <p> SEE DEMO VIDEO</p>
688 channel information	<p>Displays the name and number of the 688 channel to which the receiver is routed.</p>
Band	<p>Displays the Lectrosonics SRC's band.</p> <p><i> ⓘ This does not apply to SRb receivers.</i></p>
Pre-fade level	<p>Displays pre-fade audio level of the receiver's output on the 688 input to which it is routed.</p>
Frequency	<p>Displays the frequency to which the SRb or SRC is currently tuned. Whole number and decimal number are adjusted independently.</p> <p>On the SRb, decimal adjustments are in .1 (Normal tuning) or .025 increments (Fine tuning).</p> <p>On the SRC, the decimal adjustment value for "Normal" may be set to either .1 or .025 via the Tuning Step Size menu.</p> <p>To adjust frequency:</p> <ul style="list-style-type: none"> ▶ Turn and press Headphone encoder.
Block & Tx Switch	<p>Displays the block number and transmitter switch value.</p>
Tuning	<p>Displays current tuning group, such as Normal or Fine (for SRb). When adjusting frequency, values will be restricted to the selected tuning group.</p> <p>To cycle through tuning groups:</p> <ul style="list-style-type: none"> ▶ Slide RTN/FAV switch left.
Menu	<p>Accesses the receiver's model-specific settings, such as Compatibility mode and Tuning Step Size (for SRC).</p> <p>To access receiver's settings:</p> <ul style="list-style-type: none"> ▶ Slide RTN/FAV switch right.

Receiver Details Screen - Example B

The following example of the Receiver Details screen is for a Wisycom MCR42. Refer to Wisycom documentation for further explanation of these settings.

- ① *This section applies to Wisycom receivers, upgraded to SuperSlot, with firmware v3.5 or later. Wisycom receivers with earlier versions of firmware are treated as unislot receivers; therefore, the Receiver Details screen is not accessible.*

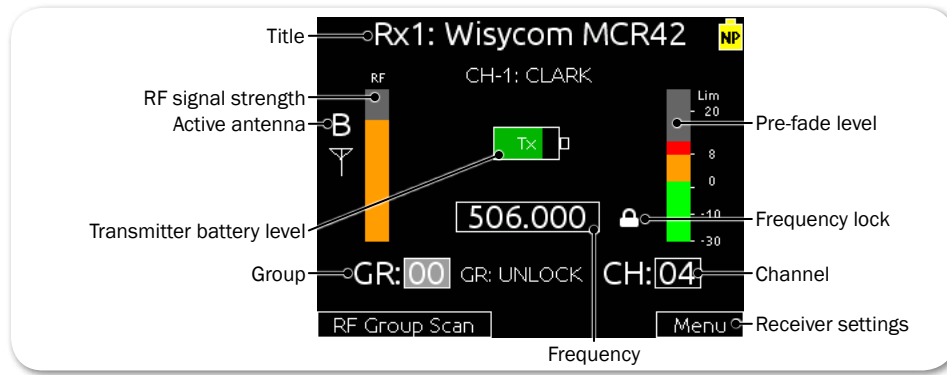

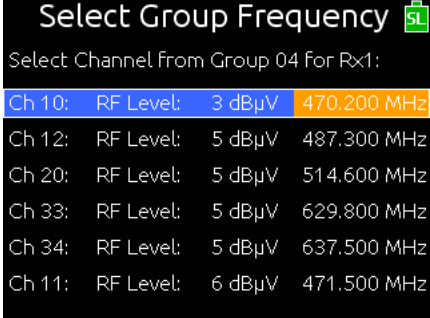

SCREEN ELEMENT	DESCRIPTION
Title	Screen's title displays the number of the receiver followed by the manufacturer and model name.
RF signal strength	Displays the strength of the RF signal.
Active antenna	Displays A or B to indicate which antenna is currently in use.
Transmitter battery level	Displays the level of the transmitter's battery. The transmitter battery level is indicated by the color of the battery icon and the level of the bar. Green = over 50%, Yellow = over 20%, Orange = over 10%, Red = less than 10%. When the transmitter battery level information is not supported, the icon is black. ① <i>This information is only provided when supported and supplied by the transmitter.</i>
GR:	Displays the current group number of the receiver. To set the group number: ▶ Turn and press Headphone encoder.

SCREEN ELEMENT	DESCRIPTION
<p>RF Group Scan</p>  SEE DEMO VIDEO	<p>Runs an RF scan of the current group for the Wisycom receiver.</p> <p>To run an RF group scan:</p> <ul style="list-style-type: none"> ▶ From the Wisycom Receiver Details screen, slide the MIC/TONE switch to the left. <p>The results of the scan will appear in a Select Group Frequency screen (shown below) from which a selected frequency may be assigned to one of the receiver’s channels.</p> 
<p>Pre-fade level</p>	<p>Displays pre-fade audio level of the receiver’s output on the 688 input to which it is routed.</p>
<p>Frequency lock</p>	<p>Lock icon is visible for channels in which the frequency is locked. Frequency cannot be adjusted when locked.</p>
<p>CH:</p>	<p>The channel number of the receiver.</p> <p>To set the channel number:</p> <ul style="list-style-type: none"> ▶ Turn and press Headphone encoder.
<p>Menu</p>	<p>Accesses the receiver’s model-specific settings.</p> <p>To access receiver’s settings:</p> <ul style="list-style-type: none"> ▶ Slide RTN/FAV switch right.
<p>Frequency</p>	<p>Displays the frequency to which the receiver is currently tuned. Whole number and decimal number are adjusted independently. Decimal adjustments in .025 increments. Not adjustable when frequency is locked.</p> <p>To adjust frequency:</p> <ul style="list-style-type: none"> ▶ Turn and press Headphone encoder.

Receiver Details Screen - Example C

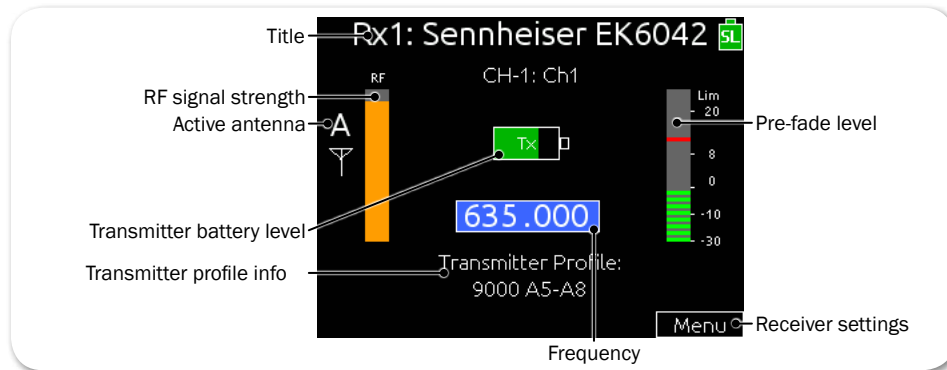
The following example of the Receiver Details screen is for a Sennheiser EK6042. Refer to Sennheiser documentation for further explanation of these settings.



SCREEN ELEMENT	DESCRIPTION
Title	Screen's title displays the number of the receiver followed by the manufacturer and model name.
RF signal strength	Displays the strength of the RF signal.
Active antenna	Displays A or B to indicate which antenna is currently in use.
Transmitter battery level	Displays the level of the transmitter's battery. The transmitter battery level is indicated by the color of the battery icon and the level of the bar. Green = over 50%, Yellow = over 20%, Orange = over 10%, Red = less than 10%. When the transmitter battery level information is not supported, the icon is black. <i>① This information is only provided when supported and supplied by the transmitter.</i>
Transmitter profile information	Displays information related to the preset transmitter profile compatible with the receiver. <i>① See Sennheiser's EK 6042 Instruction Manual for more information on transmitter profiles.</i>
Pre-fade level	Displays pre-fade audio level of the receiver's output on the 688 input to which it is routed.
Menu	<p>Accesses the receiver's model-specific settings.</p>  <p>To access receiver's settings:</p> <ul style="list-style-type: none"> ▶ Slide RTN/FAV switch right.

SCREEN ELEMENT	DESCRIPTION
Frequency	<p>Displays the frequency to which the receiver is currently tuned. Whole number and decimal number are adjusted independently. Decimal adjustments in .025 increments. Frequency range varies and is dependent on the Transmitter Profile settings of the EK-6042.</p> <p>To adjust frequency:</p> <ul style="list-style-type: none"> ▶ Turn and press Headphone encoder.

Scanning for Radio Frequencies

When the SL-6 is fitted with SuperSlot-compatible receivers, an RF Scan feature is enabled. Initiated from the Receiver Overview screen or a Receiver Details screen, the system scans the RF spectrum for RF signal activity and displays a visual image of the scan on the 688's LCD, showing what frequencies within the scanned range are free of RF interference.

① *When initiated from the Receiver Overview screen, the scan utilizes the SuperSlot receivers and draws the activity of the full range of the receivers. When initiated from a specific Receiver Details screen, the system utilizes that chosen receiver to run the scan, and will therefore be limited by the range of the receiver.*

From the scan, you may select a frequency and assign it to an available receiver channel.

To initiate an RF scan and assign a frequency :

1. Press HP + METERS to view the Receiver Overview screen.

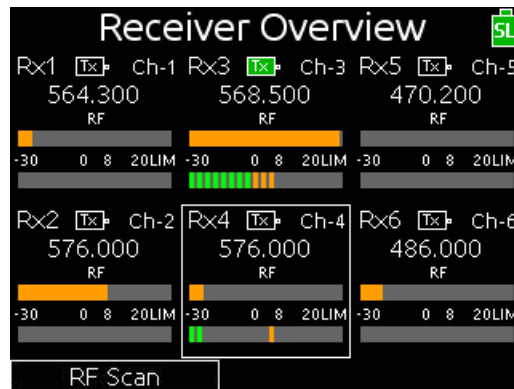

2. Slide the MIC/TONE switch to the left.

The scan displays a graph showing signal activity of the RF spectrum from low to high frequency, with a white vertical line marking the cursor position, beneath which is displayed the selected frequency.

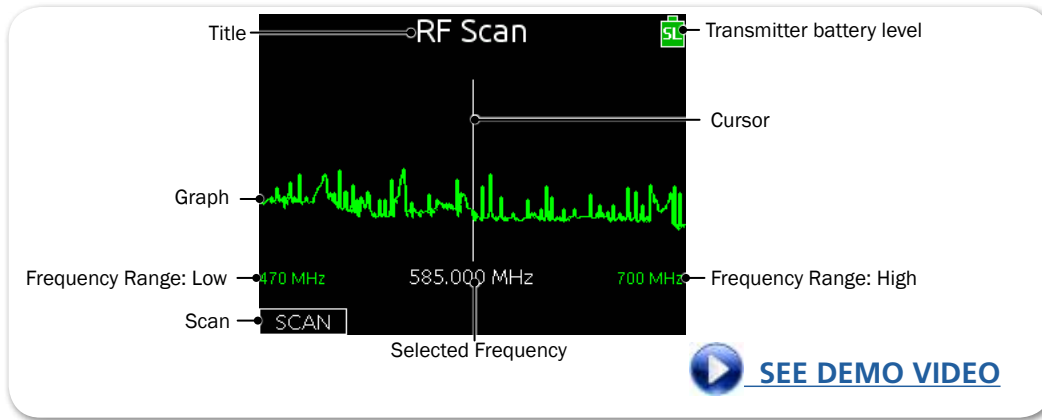

① *A scan can typically take a number of seconds. Although, with three slot-in receivers in the SL-6, the RF Scan's triple-scan capability utilizes parallel processing to cut the time it takes to run the scan by one-third.*

3. Do any of the following:
 - ▶ Turn the Select encoder to zoom in or out.
 - ▶ Turn the Headphone encoder to move the cursor and select a frequency.
 - ▶ Slide the MIC/TONE switch to the left to perform the scan again.
4. Press in the Headphone encoder to select a frequency. The Frequency Assign screen appears.

Frequency Assign	
Assign 548.200 MHz To:	
Rx1:	--
Rx2:	--
Rx3:	Wisycom MCR42 548.200 MHz
Rx4:	Wisycom MCR42 585.000 MHz
Rx5:	Lectrosonics SRb 670.500 MHz
Rx6:	Lectrosonics SRb 668.100 MHz

As shown in the illustration, the text of receiver channels that are available for assignment appear white. Gray text indicates receivers that are outside the range of the chosen frequency, and gray hyphens (--) appear when the SL-6 slot is empty.

① *For Wisycom receivers, some groups or channels may be locked, and therefore are unavailable for frequency assignment. In these cases, the text will appear gray.*

5. Use the Headphone encoder to select an available channel.

SL-6 Specifications

This section provides specifications for the SL-6 powering and wireless system, an optional accessory for the 688.

Features and specifications are subject to change. Visit the [Sound Devices website](#) for the latest product information.

Topics in this section include:

- ▶ Powering
- ▶ Antenna Distribution
- ▶ Physical

Powering

NAME	DESCRIPTION
External Power Supply	<ul style="list-style-type: none">• 10 to 18 V on locking 4-pin Hirose connector• Pin-4 = (+), Pin-1 = (-)• Mates with gold Hirose #HR10A-7P-4P (DigiKey# HR110-ND) or silver Hirose #HR10-7P-4P (DigiKey# HR100-ND) locking connector
PowerSafe	<ul style="list-style-type: none">• 10 second power reserve to SL-6, 688 (and CL-6 if connected), and attached peripherals.
USB Charging port	<ul style="list-style-type: none">• 5 V, 2 A max
DC Outputs 1-2	<ul style="list-style-type: none">• Locking, coaxial connector• Isolated• 12 V, 0.5 A max
DC Outputs 3-4	<ul style="list-style-type: none">• Locking, coaxial connector• 10 to 17 V, 0.5 A max

Antenna Distribution

NAME	DESCRIPTION
Antenna impedance	<ul style="list-style-type: none">• 50 ohm
Antenna bias voltage	<ul style="list-style-type: none">• 12 V @ 200 mA
Antenna filter ranges	<ul style="list-style-type: none">• 470-870 MHz• 470-700 MHz• 470-590 MHz• 580-700 MHz

Physical

NAME	DESCRIPTION
Dimensions (H x W x D)	<ul style="list-style-type: none">• 1.4 in x 12.7 in x 5.6 in• 3.6 cm x 32.3 cm x 14.2 cm
Weight (without receivers)	<ul style="list-style-type: none">• 2 lbs 6 oz• 1.08 kg

SOUND DEVICES

Sound Devices, LLC
E7556 Road 23 and 33
Reedsburg, Wisconsin 53959
USA

Phone: +1 (608) 524-0625
Fax: +1 (608) 524-0655

Customer Support

Toll Free: (800) 505-0625

Email: support@sounddevices.com
<http://www.sounddevices.com/support>
<http://forum.sounddevices.com>

Product Information

For more information about products and accessories, visit us on the web at www.sounddevices.com.

Report Documentation Error

Email: techpubs@sounddevices.com